

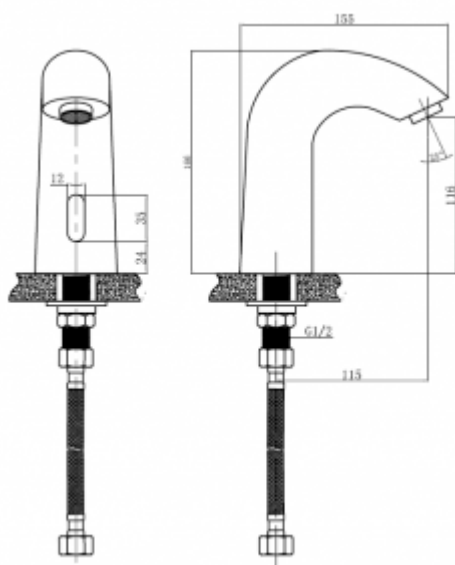

Electronic photocell battery 8155RB

- The body is made of Brass
- Two variants: 8155RB universal or 8155RB/M with a concealed mixer
- High resistance to vandalism
- Classic pattern
- Exceptional durability and reliability
- Simple operation
- Easy to assemble
- Certificate of the Polish Institute of Hygiene
- CE declaration of conformity
- National Declaration of Performance

Option	For mixed water
Connector	G1/2
Mixer	2xG1 / 2 under-basin - only with 8155RB/ M
Design	Brass
Power	Battery 4 x AA or 6v DC
Water pressure reductor	up to 6l / min
Water temperature	5-65°C
Water pressure	Min 0,5 bar - Max 6 bar (Recommended 2-4 bar)



Electronic basin faucet. It can be connected to hot, cold or mixed water. High-quality materials used for the production of time batteries ensure its long-term, trouble-free operation, and also make it extremely vandal-proof. Designed for public utility rooms.