

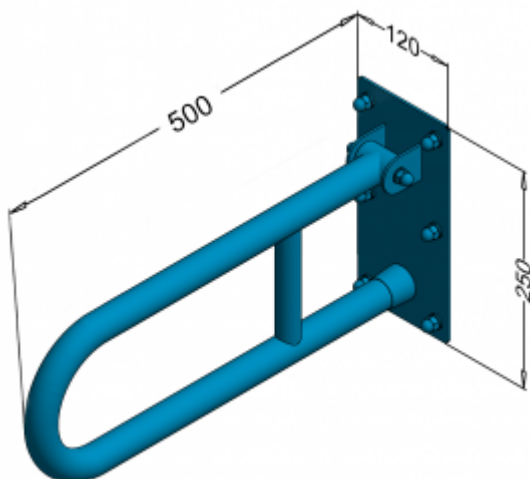

Handrail for disabled arched 50cm PSP 650

- Stainless steel cap nuts
- Corrosion resistant
- Mounting kit included
- Easy to clean

Material	AISI 304 stainless steel
finish	Gloss
Handrail type	Tilting, arched, wall mouted
Handrail length	500 mm
Tube diameter	Ø 32 mm
The wall thickness :	1,5 mm
Maximum capacity	120 kg
Hole diameter	Ø 10 mm
Number of fixing holes:	6
Includes	8x100 mm screws, 12x100 mm plugs



Arch hand-tilt, wall, for disabled people, 500 mm long, general-purpose, made of polished stainless steel tube or matt 32 mm diameter. We use this type of handrail in the washbasin, shower, and toilet area.